

SkySpec Compact Instrument v.200

TELESCOPE-SPECTROMETER SYSTEM FOR MOBILE PASSIVE REMOTE SENSING



SkySpec Compact field application with tripod and LiPo battery pack (available accessories)

- Full functional self-contained telescope-spectrometer system with embedded computer
- Compact, light-weight and low power consumption; ideal for mobile applications and measurements in remote places with little infrastructure
- Optimized for UV/Vis-aerosol and trace gas remote sensing with the DOAS method
- Detectable gases: NO₂, O₃, SO₂, HCHO, H₂O, HONO, IO, BrO, Glyoxal, O₄, ...
- Customizable to meet your specific requirements
- Software packages for spectral analysis, post-processing and data visualization available

TELESCOPE:

- Motorized viewing elevation axis, fixed azimuth
- Automatic correction of telescope viewing elevation via integrated inclination sensor
- Rugged and weather-proof design with no outside moving parts
- Integrable wide angle camera for monitoring purposes

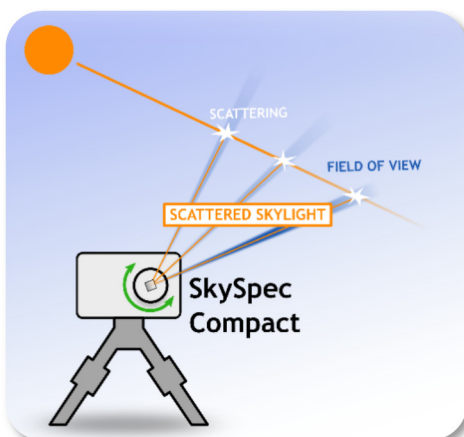

SPECTROMETER:

- High quality grating spectrometer
- Characterized and calibrated
- Active temperature stabilization
- Low straylight design
- Sub-nm spectral resolution
- High spectral sampling
- Homogenized slit illumination
- Available with Backthinned CCD detector for maximum UV sensitivity

For measurement principle, example applications and data, see SkySpec overview datasheet!

HIGHLIGHTS

Measurement accuracy

- Individual in-house spectrometer fine adjustment to optimize spectral properties
- Spectrometer characterization included: wavelength calibration, offset and dark current spectra, detector non-linearity function
- Active spectrometer temperature stabilization ensures stable properties
- High spectral sampling prevents quantization errors
- Low noise and high precision in narrow-band optical density
- Color filters and optical bench design minimize spectrometer stray-light
- Optical fiber ensures homogeneous spectrometer illumination
- Real-time correction of telescope elevation via inclination sensor, ideal for measurements on moving platforms (ships, cars) or in changing environments
- Prism deflector and optical fiber setup prevent polarization induced biases
- Small vertical field of view ($< 0.3^\circ$) optimized for vertical profiling applications

Setup, lifetime & maintenance

- Quartz glass tube design avoids outside moving parts for:
 - ▶ long lifetime even under harsh environmental conditions
 - ▶ simple cleaning
- Integrated telescope heating (activates at $< 5^\circ\text{C}$) prevents:
 - ▶ freezing of mechanical components
 - ▶ water condensation, snow and ice on quartz cylinder and other optics
- Weather proof and UV resistant IP64 housings
- 12V/DC power supply with low consumption, ideal for mobile operation via battery or car-cigarette-lighter
- Easily adaptable measurement routines
- Fast instrument power-up
- Various mounting options (tripod, rail and mast adapters available)
- Full functional self-contained system
- Access and configuration via LAN/WLAN with any web-enabled device
- Preconfigured embedded computer; measurements start after power-up

Customization

- Individual spectrometer configurations to best meet your spectral requirements

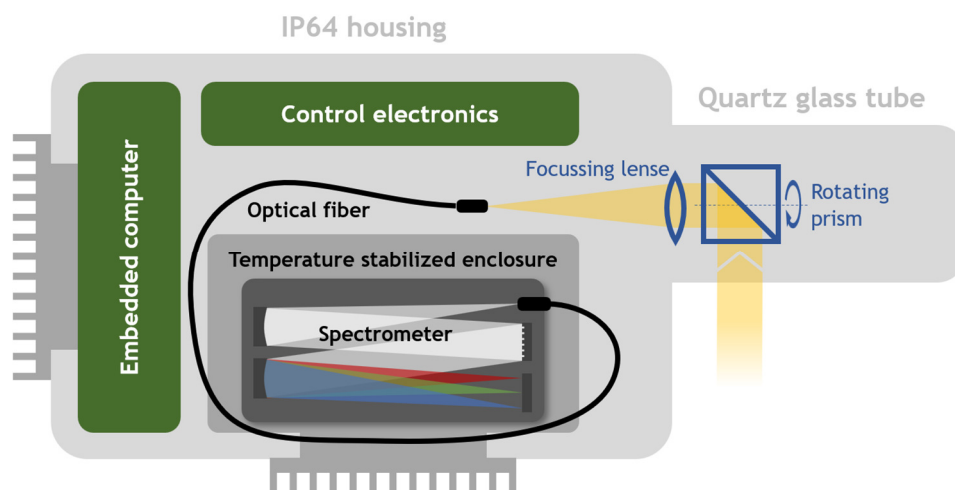

TYPICAL SPECIFICATIONS

Wavelength range	300 - 460 nm wavelength (standard) ^{*1}
Spectral resolution	< 0.7 nm FWHM (standard) ^{*1}
Optical filter	Schott BG3 or BG40 ^{*1}
Noise	< 3 · 10 ⁻⁴ at 10 ³ scans (=60s integration time)
Spectral sampling	> 5 points over slit function FWHM
Quantum efficiency	UV: > 50 % (UV, back-thinned detector)
Spectrometer temp./stability	Temperature: 20 °C (adjustable) Stability better than +/-0.03 °C
Wavelength calibration	Highly stable in-house calibration (typ. shifts < 0.01 nm), manual re-calibration possible with mercury (HG) lamp
Operation temperature range	-10 °C to 40 °C ^{*2}
Elevation range and accuracy	-10° to 190°, automatic correction with < 0.1° accuracy (1σ)
Field of view FWHM, vertical x horizontal	< 0.3° x 1°
GPS	Included
Telescope heating	Automatic, if temp. below 5 °C

^{*1} Custom specifications with different wavelength ranges are possible within certain boundary conditions to guarantee optimum spectroscopic measurements.

^{*2} Temperature can exceed the operation range in direct sun light.

Mechanical stability	Water proof (IP 64), sun roof, robust and simple mounting
Additional Sensors	Temperature: 1 °C accuracy, telescope, spectrometer, electronics Pressure: 0.5 % accuracy, ambient Humidity: ± 3 % accuracy in relative humidity, Sensor inside instrument
Measurement software	Included, customizable measurement routine (angles, time resolution) on embedded PC with Windows 10 Prof.
Start-up time	< 3 min
Data communication	LAN / WiFi
Power consumption	Typ. < 30 W (max. 100 W), 12 V
Weight	≈ 7 kg
Size (WxDxH)	Box: 30 x 20 x 13.2 cm ³ (box only) Quartz tube (LxD): 16 cm x 8 cm

OPTIONAL COMPONENTS & CONFIGURATIONS

- Custom spectrometer configuration and low-cost spectrometer options
- Tripod and various mounting adapters
- Handheld mercury (HG) wavelength calibration lamp
- Mobile LiPo battery in Peli case (50 Ah, 13.6 V)
- Integrated, wide FOV camera to monitor measurement conditions
- Spare parts and maintenance set
- Spectral evaluation software packages
- Online installation and support service

DIMENSIONS

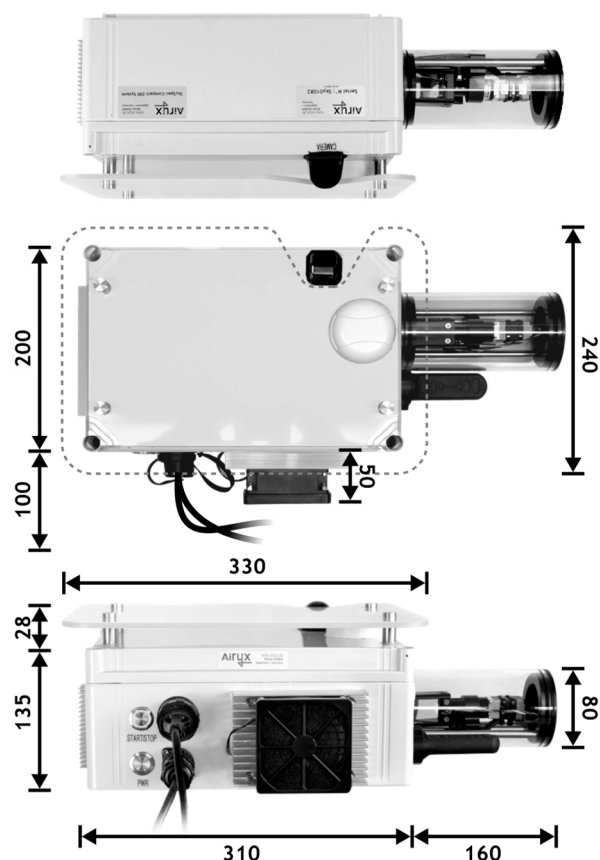

All dimensions in mm